



*Your Portable Exchange
& DI Equipment Supplier*

2022/2023 Wholesale Pricing Catalog

www.amproduct.com

4242 1st Ave Ste A • Lyons, IL 60534
Phone & Fax • 920-686-0000 | mail@amproduct.com



*Associate
Member*
CDANA



"We supply quality products at a reasonable price while providing exceptional customer service."

AM Products & Services is a division of Specialty Sales LLC. Specialty Sales is a family-owned stocking distributor of a full line of Hose, Tubing, Fittings, Clamps, Valves & other components for the water treatment industry. If you need assistance with sourcing items beyond this catalog, please just ask. You can visit us at www.specialty-sales.com.

Table of Contents

Slip Style Parts (Culligan)	1-3
Yoke Style Parts (Servisoft, Rayne)	4
Park DI Fittings	5
Park DI Fitting Hose Assemblies	5
Tank Adapters	6
Distributors & Parts	7
Fiberglass DI Tanks	8
Stainless Steel Tanks	9
Bypasses	10
Cart Parts	10
Carrying Slings & Aprons	10
Flow Controls	11
Tank Carts - Standard & Side Loader, and Salt Cart	12
Bottle Water Carts	13
Eductors	14
Cam Couplings	15
Miscellaneous	16

Catalog available online at
www.amproduct.com

Give us a chance to locate your hard to find items!

Credit Cards

- Credit Card payments are accepted for new customers prior to credit checks, and will be charged at the time of shipping.
- Credit Cards cannot be combined/used with any discounts.

Do you wish you had a vendor that would stock the parts you need? Give us an opportunity!

Call us at 920-686-0000 (Phone & Fax)
Email mail@amproduct.com

Notes

- Call Donald Zelinski (920) 973-3669 if unable to get through on the other number (920) 686-0000.
- Many parts not listed are available. Please call for prices and availability.
- Larger quantity discounts may be available.
- Parts and prices listed are for wholesale customers.
- Orders may be placed by phone, and email 365 days a year, 24 hours a day.
- Returns must be pre-arranged.
- Our prices are based on your payment being received within our terms. It is not fair to our customers that pay within our terms if we allow late payments. Customers with a history of paying late will have their costs automatically increased by 2%.
- As a service to our customers, AM Products will set up larger shipments to go by truck. We use freight brokers to get the best value for our customers. However, when a truck company changes the class that a shipment is originally set at, this may lead to an additional cost to the customer that we have no control over. When this happens, we will fight for the original amount, but if the truck company will not change the rate, we will have to pass that along to the customer on a separate invoice.
- All truck shipments must be inspected for loss and/or damage immediately and reported to the truck drivers.
- All shortages/damage to package shipments must be reported within 2 weeks of receipt. All cartons must be kept for carrier inspections.

Slip Style (Culligan) Products



Fittings



Male Coupling

Part No.	Description	Price	Price Break
222000LF	3/4" Male Coupling - Inlet Lead Free Brass	\$11.81	100+ \$11.41
222003LF	3/4" Male Coupling Outlet Lead Free Brass	\$12.07	100+ \$11.86
222001-304	3/4" Male Coupling Stainless Steel - Outlet 304SS	\$17.54	500+ \$16.93
222001-316	3/4" Male Coupling Outlet 316SS	\$20.18	
222002-304	3/4" Male Coupling Stainless Steel - Inlet 304SS	\$16.90	500+ \$16.40
222002-316	3/4" Male Coupling - Inlet 316SS	\$19.45	
222002-P-304	3/4" Male Coupling Stainless Steel 304SS (for plastic threads)	\$16.90	500+ \$16.40
222002-P316	3/4" Male Coupling 316SS (for plastic threads)	\$19.45	
222002-P-304-1"	1" Male Coupling 304SS (for plastic threads)	\$16.90	



Hose Fitting

222040LF	Hose Fitting- Lead Free Brass	\$15.47	100+ \$15.28
222041-316	Hose Fitting - 316SS	\$25.05	
222041-304	Hose Fitting-Stainless Steel	\$21.61	



Adapter

222080LF	Adapter Lead Free Brass 1/2" MPT	\$12.69	
222060LF	Adapter Lead Free Brass 3/4" MPT	\$13.62	
222081-304	Adapter-Stainless Steel 1/2" MPT 304SS	\$18.31	500+ \$17.61
222082-304	Adapter-Stainless Steel 3/4" MPT 304SS	\$18.31	
222081-316	Adapter 1/2" MPT 316SS	\$20.19	
222082-316	Adapter 3/4" MPT 316SS	\$20.19	



MPT x Barb

222009	1/2" MPT x 3/4" Barb Brass	\$4.01	
222010LF	3/4" MPT x 3/4" Barb Lead Free Brass	\$4.60	
222011-316	3/4" MPT x 3/4" Barb 316 Stainless	\$10.28	
222012-316	1/2" MPT x 3/4" Barb 316 Stainless	\$12.67	
330414	3/4" MPT x 3/4" Barb PVC	\$0.98	
330426	1/2" MPT x 3/4" Barb PVC	\$1.82	
330415	1" MPT x 1" Barb PVC	\$0.77	
222015	Female Garden Hose x 3/4" Barb LFB	\$12.46	

Hose Assemblies



Most hose assemblies are made per order. Any length or fitting combination can be requested.

210000Gray	4.5" Hose Connector - LF Brass Gray Hose	\$26.65	
210000Black	4.5" Hose Connector - LF Brass Black Hose	\$27.89	
210000Blue	4.5" Hose Connector - LF Brass Blue Hose	\$27.89	
210015Blue	6" Hose Connector - LF Brass Blue Hose	\$27.89	
210001Gray	8.5" Hose Connector - LF Brass Gray Hose	\$26.65	100+ \$25.47
210001Black	8.5" Hose Connector - LF Brass Black Hose	\$27.89	100+ \$27.71
210001Blue	8.5" Hose Connector - LF Brass Blue Hose	\$27.89	100+ \$27.71
210002Gray	8.5" Hose Connector - 1/2 SS MPT 304SS DI Gray Hose	\$39.92	
210002Blue	8.5" Hose Connector - 1/2 SS MPT 304SS DI Blue Hose	\$40.76	
210002-316Gray	8.5" Hose Connector - 1/2 SS MPT 316SS-DI Gray Hose	\$43.36	
210002-316Blue	8.5" Hose Connector - 1/2 SS MPT 316SS-DI Blue Hose	\$44.20	
210003Gray	8.5" Hose Connector 3/4 SS MPT 304SS DI Gray Hose	\$37.53	
210003Blue	8.5" Hose Connector 3/4 SS MPT 304SS DI Blue Hose	\$38.37	
210003-316Gray	8.5" Hose Connector - 3/4 SS MPT 316SS-DI Gray Hose	\$40.97	
210003-316Blue	8.5" Hose Connector - 3/4 SS MPT 316SS-DI Blue Hose	\$41.81	
210004Gray	8.5" Hose Connector 1/2 PVC MPT & 304SS DI Gray Hose	\$32.20	

Slip Style (Culligan) Products

Hose Assemblies (continued)



Most hose assemblies are made per order. Any length or fitting combination can be requested.

Part No.	Description	
210004Blue	8.5" Hose Connector 1/2 PVC MPT & 304SS DI Blue Hose	\$33.04
210005Gray	8.5" Hose Connector 3/4 PVC MPT & 304SS DI Gray Hose	\$31.36
210005Blue	8.5" Hose Connector 3/4 PVC MPT & 304SS DI Blue Hose	\$32.20
210013Gray	18" Hose Connector LF Brass Gray Hose	\$28.79
210013Black	18" Hose Connector LF Brass Black Hose	\$30.87
210013Blue	18" Hose Connector LF Brass Blue Hose	\$30.87
210014Gray	18" Hose Connector DI Gray Hose	Call
210014Blue	18" Hose Connector DI Blue Hose	Call
210006Gray	18" Jumper Hose w/Lok Rings DI Gray Hose	\$52.36
210006Blue	18" Jumper Hose w/Lok Rings DI Blue Hose	\$54.83
210006-316Gray	18" Jumper Hose w/Lok Rings 316SS-DI Gray Hose	\$57.28
210006-316Blue	18" Jumper Hose w/Lok Rings 316SS-DI Blue Hose	\$58.96
210017Gray	24" Jumper Hose w/Lok Rings 304SS Gray Hose	\$54.50
210017Blue	24" Jumper Hose w/Lok Rings 304SS Blue Hose	\$57.81
210017-316Gray	24" Jumper Hose w/Lok Rings 316SS Gray Hose	\$59.42
210017-316Blue	24" Jumper Hose w/Lok Rings 316SS Blue Hose	\$61.94
210007Gray	18" Jumper Hose w/Lok Rings LF Brass Gray Hose	\$46.06
210007Black	18" Jumper Hose w/Lok Rings LF Brass Black Hose	\$48.28
210007Blue	18" Jumper Hose w/Lok Rings LF Brass Blue Hose	\$48.28
210016Blue	24" Jumper Hose w/Lok Rings LF Brass Blue Hose	\$51.26
210016Gray	24" Jumper Hose w/Lok Rings LF Brass Gray Hose	\$48.20
210016Black	24" Jumper Hose w/Lok Rings LF Brass Black Hose	\$51.26
210008Gray	24" Hose Connector LF Brass Gray Hose	\$30.93
210008Black	24" Hose Connector LF Brass Black Hose	\$33.85
210008Blue	24" Hose Connector LF Brass Blue Hose	\$33.85
210009Gray	24" Hose Connector 1/2 SS MPT 304SS DI Gray Hose	\$44.20
210009Blue	24" Hose Connector 1/2 SS MPT 304SS DI Blue Hose	\$46.77
210009-316Blue	24" Hose Connector 1/2 SS MPT 316SS DI Blue Hose	\$47.64
210010Gray	24" Hose Connector 3/4 SS MPT SS DI Gray Hose	\$41.81
210010Blue	24" Hose Connector 3/4 SS MPT SS DI Blue Hose	\$46.72
210011Gray	24" Hose Connector 1/2 PVC MPT & 304SS DI Gray Hose	\$36.48
210011Blue	24" Hose Connector 1/2 PVC MPT & 304SS DI Blue Hose	\$39.00
210012Gray	24" Hose Connector 3/4 PVC MPT & 304SS DI Gray Hose	\$35.64
210012Blue	24" Hose Connector 3/4 PVC MPT & 304SS DI Blue Hose	\$38.16

--Gray & Blue Hose are High Purity Water Hose - NSF - FDA
 --Black Hose is Unrated Water Hose
 --For longer hoses, add "Per Foot" price found below for each foot or partial foot addition to above prices.

3/4" Reinforced DI & Softener Hose (Gray cover)
 3/4" ID x 1.03" OD 150 PSI 150 F

500531		\$2.14 per foot
500531-100	100 ft Roll	\$1.48 per foot
500531-300	300 ft Roll	\$1.38 per foot

1/2" Reinforced Hose (Gray cover)
 1/2" ID x 3/4" OD 200 PSI 150 F

500499		\$1.42 per foot
500499-300	300 ft Roll	\$1.01 per foot

3/4" Reinforced DI & Softener Hose (Blue cover)
 3/4 ID x 1.125" OD 250 PSI 150 F

500532		\$2.98 per foot
500532-100	100 ft Roll	\$2.10 per foot
500532-500	500 ft Roll	\$2.00 per foot

1" Reinforced DI & Softener Hose (Gray cover)
 1" ID x 1.29" OD 125 PSI 150 F

500533		\$3.28 per foot
500533-100	100 ft Roll	\$2.11 per foot
500533-200	200 ft Roll	\$1.98 per foot

3/4" Reinforced Black Hose - not rated for potable water
 3/4" ID x 1.12" OD 200 PSI 190 F

500530		\$2.98 per foot
500530-100	100 ft Roll	\$2.10 per foot
500530-500	500 ft Roll	\$2.00 per foot

Gray hose also available in 1/4", 3/8", 1-1/4", 1-1/2" and 2" ID

Slip Style (Culligan) Products (continued)



Gaskets



Gasket

Part No.	Description	Price	Price Breaks	
221000	Gasket-Silicone Treated Black EP .53 x .923 x .208	\$0.33	100+	\$0.22
221010	Gasket White Striped SBR .52 x .92 x .227	\$0.34	100+	\$0.23
221300	Gasket-Backwash .625 x 1.0 x .187	\$0.36	100+	\$0.31
221300-OR	O-Ring Backwash	\$0.23		
221002	Gasket - comparable to Culligan molded gasket .555 x .935 x .197	\$0.33	100+	\$0.22
			500+	\$0.19
221005	Fiber Spacer Washer	\$0.26	100+	\$0.23

Distributors/Manifolds

Distributor



Different slot sizes available. 100+ pricing will require a short lead time. Custom distributors available.

220102	Inlet Distributor-PVC 2.875"	\$2.23	100+	\$2.17
220105	Inlet Distributor-PVC 7"	\$2.61	100+	\$2.55
220107	Inlet Distributor-Hot Water CPVC 7"	\$12.35		
220109	Inlet Distributor - Hot Water CPVC 2.875"	\$11.13		
220106	Inlet Distributor-Wide Slot PVC 2.875"	\$2.75	100+	\$2.69
220103	Outlet Distributor-D-50 - CPVC	\$18.80	300+	\$18.35
220300LF	Male Coupling #222003LF & 42" Distributor #220311 Assembly	\$20.46	100+	\$20.30
220311	Outlet Distributor-42" PVC	\$7.39	110+	\$7.05
220312	Outlet Distributor-42" Hot Water CPVC	\$15.94	100+	\$15.59
220313	Outlet Distributor - 42" (Hockey Stick Style)	\$8.48	100+	\$8.20
220314	Outlet Distributor - 42" Hot water CPVC (Hockey Stick Style)	\$20.64		
220110	Inlet Distributor-14" Tank PVC	Call		
220315	Outlet Distributor-14" Tank PVC	Call		
220110SS	Inlet Distributor 14" Tank-Stainless	Call		
220315SS	Outlet Distributor 14" Tank-Stainless	Call		
220317LF	Male Coupling #222003LF & 42" CPVC Distributor Assembly	\$29.01		

NOTE: CPVC 180 Degrees F; PVC 130 Degrees F

Miscellaneous



DI Funnel Valve



Rubber Cap



Coupling Wrench











Conical Adaptor

230431	Brass Backwash Adaptor - Plastic Yoke Tanks	\$27.02		
500540	Funnel Tubing 1.5" Clear, Flexible PVC	\$7.71/ft		
230540	Rubber Boot/Funnel Connector	\$14.67		
230430	Conical Adaptor (Funnel connector)	\$15.12		
230561	DI Funnel Valve 1 5/8"x5/8"	\$79.80		
230561-RK	DI Funnel Valve Repair Kit	\$20.73		
210100	Rubber Cap (EPDM)	\$0.86	100+	\$0.83
230560	Softener/Filter Funnel Valve	\$66.31		
210090-B	Lok Ring - Black	\$0.48	100+	\$0.45
210090-R	Lok Ring - Red	\$0.51	100+	\$0.48
250030	Male Coupling Wrench	\$42.41		
210091	Yoke Jam Nut - Brass	\$4.79	100+	\$4.72
220104	Outlet Safety Screen - PVC	\$2.12	100+	\$2.00
220108	Outlet Safety Screen - Wire 40 Mesh 304ss (220104 & 220108 replace screened gasket)	\$2.63	100+	\$2.56
220111	Outlet Safety Screen for 2.5" Plastic Heads - PVC	\$2.94	50+	\$2.89
220112	Outlet Safety Screen for 4.5" Plastic Heads - PVC	\$2.94	50+	\$2.89
240000	PE Tank Bag/Bladder Kit (contains 1 bag, 1 gasket, 1 spacer)	\$45.00	20+	\$35.70
240001	PE Tank Bag/Bladder Gasket	\$5.10	25+	\$4.61
240002	PE Tank Bag/Bladder Spacer	\$2.96	25+	\$1.47
500502	Clear Resin Testing Tube .54" OD x 48"	\$9.00		

Yoke Style (Servisoft, Rayne) Products



	Part No.	Yoke Size	Description	Price	Qty Break	Qty Pricing
 Connector Assembly	330062-LF	3/4"	Connector Assy - Lead Free Brass	\$20.87	100+	\$20.26
	330063-LF	3/4"	Connector Body - Lead Free Brass	\$14.84	100+	\$14.34
	330067-LF	1"	Connector Assy - Lead Free Brass	\$25.64	100+	\$25.18
	330066-LF	1"	Connector Body - Lead Free Brass	\$20.87	100+	\$20.38
 Strap	330070	3/4" & 1"	Strap	\$3.26	100+	\$3.02
	330070	3/4" & 1"	Strap		500+	\$2.95
	330090	3/4" & 1"	Side Bolt	\$0.49	100+	\$0.37
	330090	3/4" & 1"	Side Bolt		500+	\$0.33
	330081	3/4" & 1"	Center Bolt-S.S. Hex head 5/16"-18-1.5"	\$0.35	100+	\$0.26
 Bolt	330082	3/4" & 1"	Center Bolt-Plated Square Head	\$0.34	500+	\$0.33
	330083	N/A	S.S.Nut	\$0.32	500+	\$0.27
	330084	N/A	Yoke Strap Clip Nut	\$0.97	100+	\$0.91
 Tank Fitting	330160	3/4"	Yoke O-Ring	\$0.29	100+	\$0.25
	330160 EPDM	3/4"	Yoke O-Ring	\$0.30	1000+	\$0.19
	330161	3/4"	Yoke O-Ring Oversized	\$0.31	100+	\$0.25
	330161	3/4"	Yoke O-Ring Oversized		500+	\$0.22
	330162	1"	Yoke Gasket	\$0.41	100+	\$0.33
	330162	1"	Yoke Gasket		1000+	\$0.25
 Spring	330310-LF	3/4"	Tank Fitting Brass - Outlet Lead Free Brass	\$21.02	100+	\$20.38
	330300-LF	3/4"	Tank Fitting Brass - Inlet Lead Free Brass	\$21.31	100+	\$20.62
	330312-LF	1"	Tank Fitting - Lead Free Brass	\$26.00	100+	\$25.16
	330040	3/4"	1 1/4" Spring	\$0.28	100+	\$0.24
 <i>Different slot sizes available. 100+ pricing will require a short lead time. Custom distributors available. CPVC - 200 degrees F PCV - 140 degrees F</i>	330041	1"	Inlet/Outlet Spring	\$0.27	100+	\$0.19
	330042	1"	Inlet/Outlet Spring - Heavy Duty	\$0.29	100+	\$0.26
	330050	3/4"	2 1/2" Outlet Spring	\$0.32	100+	\$0.28
	330051	1"	Outlet Spring	\$1.35	100+	\$1.27
	330354	1"	5" Inlet Distributor	\$4.63		
	330361	3/4"	7" Dist. Grey PVC Heavy Wall	\$5.56		
	330363	3/4"	7" Dist. - CPVC - Hot Water	\$9.16		
	330364	1"	7" Dist. - Grey PVC	\$5.02		
	330365	1"	7" Dist. CPVC Hot Water	\$10.69		
	330371	3/4"	9" Dist. - Grey PVC Heavy Wall	\$5.03		
330373	3/4"	9" Dist. - CPVC	\$11.40			
330374	1"	9" Dist. - Grey PVC	\$5.69			
330381	3/4"	11" Dist. - Grey PVC Heavy Wall	\$5.62			
330383	3/4"	11" Dist. - CPVC - Hot Water	\$13.14			
330384	1"	11" Dist. - Grey PVC	\$6.15			
330391	3/4"	35-1/2 Dist.	\$6.56			
330394	1"	35-3/4 Dist. Grey PVC	\$7.80			
330395	1"	35-3/4 Dist. Grey CPVC Hot Water	\$18.55			
 Plug	330064	3/4" & 1"	Disc Screen (40 mesh) 1 3/8" Diameter	\$0.35	100+	\$0.24
	330065	3/4"	Transport Plug	N/A	100+	\$0.15
	330020LF	3/4"	Plug Lead Free-Brass 5/8" - Hex Drive	\$4.04		
	330022LF	1"	Plug Lead Free-Brass 5/8" - Hex Drive	\$6.85	100+	\$6.10
	330031	1"	Plug-Zinc-Square Drive	N/A	100+	\$4.35
	330130	3/4"	O-Ring 3/4" Plug	\$0.25	100+	\$0.15
	330411	1"	O-Ring 1" Plug	\$0.27	100+	\$0.20
	330033	1"	Distributor Gasket	\$0.18	100+	\$0.15
	330100	N/A	O-Ring-1 1/2 Cap	\$0.26	100+	\$0.18
	330100	N/A	O-Ring-1 1/2 Cap		500+	\$0.16
	330032	3/4"	Distributor Gasket	\$0.17	100+	\$0.12
	 Cap	331000	N/A	1 1/2 Zinc Cap Bar Drive	\$2.85	100+
331003SS			1 1/2 Stainless Cap-Square Drive	\$17.92	100+	\$17.57
331003SSR			1 1/2 Stainless Cap-Square Drive Rayne Style	\$17.92	100+	\$17.57
331004		N/A	1 1/2 Zinc Cap-Square Drive		500+	\$15.76
331003LFB			1 1/2 Lead Free Brass Cap - Square Drive	\$14.96	100+	\$14.76
331003LFB			1 1/2 Lead Free Brass Cap - Square Drive Rayne Style	\$14.96	100+	\$14.76
					500+	\$14.32

Park DI Fittings



Description	AM Products #	Park #	Price	25+	50+
3/4" MPT x MUT	330400	MA-75	\$4.30	\$2.90	\$2.65
3/4" MPT x Reverse MUT	330400LHUT	MA-75	\$4.30	\$2.90	\$2.65
3/4" MPT x MUT w/1/2" threads	330400IT	MA-75	\$6.52		
3/4" MPT X FUT	330401	UMA-75	\$5.80	\$4.40	\$4.15
3/4" MPT X FUT Reverse MUT	330401LHUT	UMA-75	\$5.80	\$4.40	\$4.15
3/4" MPT x FUT w 1/2" threads	330401IT	UMA-75	\$7.82		
3/4" HB X MUT	330402	HB-75	\$4.30	\$2.90	\$2.65
3/4" HB X MUT Reverse MUT	330402LHUT	HB-75	\$4.30	\$2.90	\$2.65
3/4" HB X FUT	330403	UHB-75	\$5.80	\$4.40	\$4.15
1" MPT X MUT	330404	MA-100	\$4.30	\$2.90	\$2.65
1" MPT X MUT Reverse MUT	330404LHUT	MA-100	\$4.30	\$2.90	\$2.65
1" MPT X FUT	330405	UMA-100	\$5.80	\$4.40	\$4.15
1" MPT X FUT Reverse FUT	330405LHUT	UMA-100	\$5.80	\$4.40	\$4.15
1" HB X MUT	330406	HB-100	\$4.30	\$2.90	\$2.65
1" HB X MUT Reverse MUT	330406LHUT	HB-100	\$4.30	\$2.90	\$2.65
1" HB X FUT	330407	UHB-100	\$5.80	\$4.40	\$4.15
Plug - Black	330408-B	PLUG-UN	\$3.10	\$1.85	\$1.60
Plug - White	330408-W	PLUG-UN	\$3.10	\$1.85	\$1.60
Plug - Reverse MUT	330408-LHUT	PLUG-UN	\$3.10	\$1.85	\$1.60
Cap - Black	330409-B	CAP-MA	\$3.00	\$1.75	\$1.50
Cap - White	330409-W	CAP-MA	\$3.00	\$1.75	\$1.50
Cap - Reverse MUT	330409-LHUT	CAP-MA	\$3.00	\$1.75	\$1.50
Inlet Distributor 3/4" PVC-Drop In	330410	N/A	\$3.62	\$3.19	\$3.07
Inlet Distributor 1" Black PVC	330413-B		\$4.58	\$4.18	\$4.06
Inlet Distributor 1" CPVC	330413-CPVC		\$14.78	50+	\$14.51
Outlet Distributor	Call				
2.5" Head Outlet Safety Screen	330431		\$4.16	\$3.82	\$3.67
4.5" Head Outlet Safety Screen	330432		\$2.79	\$2.55	\$2.45
O-Ring (EPDM)	330411	N/A	\$0.30	100+	\$0.22
O-Ring (Viton)	330412	N/A	\$0.65	100+	\$0.55
3/4" MPT x 3/4" Barb PVC Adapter	330414		\$0.98		
1" MPT x 1" Barb PVC Adapter	330415		\$0.77		
1/2" MPT x 3/4" Barb PVC Adapter	330426		\$1.82		

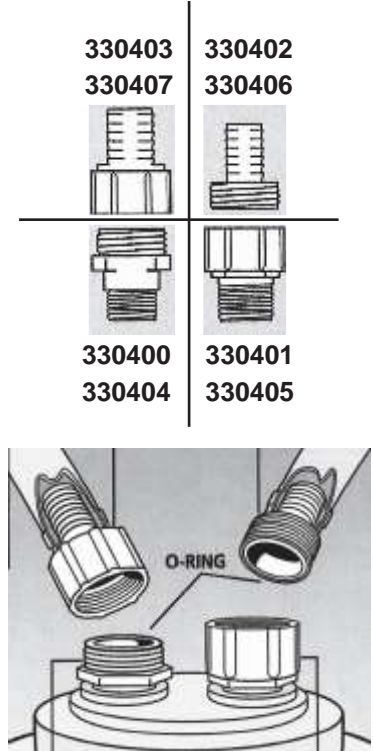

Notes:
 - Max Limits 270°F & 150 PSI
 - NSF Grade Glass Filled Noryl
 - Plugs & caps Polypropylene
 - To bore for glueing outlet distributor 330400 or 330401 - \$2.30

MPT = Male Pipe Thread
 MUT = Male Union Thread
 FUT = Female Union Thread
 LHUT = Left Handed/Reverse Union Thread
 IT = Inside Thread
 HB = Hose Barb

Please be certain you are ordering correctly as these hose assemblies are custom made per order and are not returnable.

Park DI Fitting Hose Assemblies

Part #	Description	Price
3/4" (specify Length - Add \$2.14/ft Gray Hose; Add \$2.88/ft Blue Hose)		
330416	330402 HB x 330403 UHB	\$20.10
330417	330402 HB x 330402 HB	\$18.60
330418	330414 PVC MPT x 330414 PVC MPT	\$15.32
330419	330402 HB x 330414 MPT	\$16.94
330420	330403 UHB x 330414 MPT	\$18.44
330427	222012 1/2" SS x 330403	\$30.00
330428	222012 1/2" SS x 330402	\$26.50
330429	222011 3/4" SS x 330403	\$27.02
1" (specify length - Add \$3.15/ft Gray Hose)		
330421	330406 HB x 330407 UHB	\$20.10
330422	330406 HB x 330406 HB	\$18.60
330423	330415 PVC MPT x 330415 PVC MPT	\$15.31
330424	330406 HB x 330415 PVC MPT	\$16.96
330425	330407 UHB x 330415 PVC MPT	\$18.46

See Page 2 for bulk hose material pricing



Adapters

	Qty 1-9	Qty 10+
2.5" - 8 Tank Threads - 3/4" Inlet & Outlet-ABS		
330500 - 1/2" Dist. port	\$24.60	19.60
330500IS - w/glued on Inlet Screen	\$25.71	20.71
330501 - 1/2" Dist. port - 3/4" Fill port	\$25.63	20.63
-- Optional 13/16" Dist. port		
330501IS - - w/glued on Inlet Screen	\$26.80	21.80
330502 - 1/2" Dist. port - 3/4" Fill port	\$17.98	14.09
-- Optional 13/16" Dist. port & 1/4" In/Out		
330503 - 1/2" Dist. port	\$17.61	13.61
-- Optional 13/16" & 3/4" Dist. port		
2.5" - 8 Tank Threads - 1" Inlet & Outlet-ABS		
330505 - 1" Dist. port	\$22.10	17.10
-- Optional 3/4" Dist. port		
4.5" - 8 Tank Threads - 1" Inlet & Outlet - Glass Filled ABS - Glued on Inlet Screen - Stainless Bands		
330506 - 1" Dist. port - 1.5" Fill port	\$24.38	19.38
330507 - 1" Dist. port - 2 hole	\$22.85	17.85
Inlet & Outlet only		
330508 - 1" Dist. port - 3rd 1" Top port	\$23.65	18.54
-- Optionals include threaded Dist. port, inlet diffuser, threaded inlet screen		
2.5" - 8 Tank Threads Noryl 3/4" (1.05") Dist. port		
330563 - 0.75 3/4" In & Out	\$28.57	
330563 - 1.00 1" In & Out	\$28.57	
330564 Inlet Screen	\$2.35	
330564-S w/SS screws	\$4.48	
4" Threads Noryl 1.5" Dist. port		
330565 1.5" In & Out	\$38.89	
330566 Inlet Screen	\$59.63	

PVC Heads also available



Outlet Distributors

Notes:

- Riser diameters
13/16"-.810 OD
1/2"-.845 OD
3/4"-1.050 OD
1"-1.315 OD
- Standard adapter colors are black, natural, and white. Custom colors available.
- Slot sizes on diffusers, screens, and distributors - 0.013.
- NSF Grade ABS
330500
330501
330502
330503
330505
- NSF Grade ABS Glass Filled - 4.5" Heads
- 150 PSI Operating Pressure
- 175 degrees F Max Operating Temperature

Fill Caps With O-Rings

	Qty 1-19	Qty 20+
330510 - 3/4" Fill cap (used on 330501)	1.53	\$1.40
330511 - 3/4" Fill cap (used on 330502)	1.38	\$1.23
330512 - 1" Fill cap (used on 330508)	3.19	\$2.99
330513 - 1.5" Fill cap (used on 330506)	3.37	\$3.22
330513 - CH 1.5" Fill cap Bushing with 1" FPT Center Hole	3.22	\$3.07

O-Rings

330514 - 3/4" Fill cap (330501 + 330502)	0.40	\$0.30
330515 - 2.5" x 8 Adapter	0.76	\$0.66
330509 - 1.5" Fill cap (330513 & 330513-CH)	0.40	\$0.30
330517 - 4.5" x 8 Adapter	1.88	\$1.79
330550 - 4.5" x 8 Riser & 1" Fill Cap	0.40	\$0.30
330554 - 1/2" Riser Tube	0.26	\$0.16

Diffusers & Screens

Inlet Distributors for Park Fittings - See Page 6		
330519 - Inlet Screen 2.5" Adapters	3.30	\$3.15
330531 - Inlet Screen 2.5" Adapters (330505)	3.30	\$3.15
330520 - Inlet Diffuser 4.5" Adapters (330506)	3.30	\$3.15
330552 - Inlet Screen 4.5" Adapters	2.67	\$2.52

Outlet Distributors-Basket Only

330521 - 1" x 1 Offset Outlet Distributors 7 slots	6.82	\$6.67
330522 - 1" x 2 Offset Outlet Distributors 14 slots	9.02	\$8.87
330523 - 1" x 3 Offset Outlet Distributors 21 slots	14.86	\$14.71
330524 - 1" x 4 Offset Outlet Distributors 28 slots	16.80	\$16.65
330525 - 1" x 2 Offset Hot Water Distributors	12.70	\$12.55
330526 - 1" x 4 Offset Hot Water Distributors	19.31	\$19.16
330527 - 1.5" x 1 Outlet Distributors	6.82	\$6.67
330528 - 1.5" x 2 Outlet Distributors	9.02	\$8.87
330529 - 1.5" x 3 Outlet Distributors	11.96	\$11.81
330530 - 1.5" x 4 Outlet Distributors	18.05	\$18.20
330533 - 1" Outlet Distributors	4.17	\$4.02
330534 - 13/16" (0.810) Outlet Distributors	2.78	\$2.59
330535 - 1/2" (0.845) Outlet Distributors	2.78	\$2.59
330535HW - 1/2" (0.845") Hot Water Outlet Distributor 180 degrees	3.88	\$3.73
330536 - 3/4" (1.050) Outlet Distributors	2.78	\$2.59

Riser Tubes

330555 - 1.050" x 48" Grey PCV Tube	4.98	\$4.83
330551 - 13/16" x 48" Black PVC Tube	4.47	\$3.60

Caps

330537 - 2.5" x 8 Cap	4.93	\$4.78
330538 - 2.5" x 8 Flanged cap	5.26	\$5.30

Tank Bushing

330539 - 2.5" x 4	11.96	\$11.81
330540 - 2.5" x 4.5	11.96	\$11.81

Slotted Tubes Sch 80 PVC

330541 - 1/2" MPT x 6" w/.010 slots	\$16.18
330542 - 3/4" MPT x 6" w/.010 slots	\$13.58

Outlet Safety Screens - PVC Drop In

	Qty 1-24	25+	50+
330431 For 330500 & 330501	\$3.78	\$3.47	\$3.33
330432 For 330506, 330507, 330508	\$3.78	\$3.47	\$3.33

Fiberglass DI Tanks



Model #	Tank Size	Gaylord Qty	In Stock	Capacity c.f.	Gaylord Price Per	Less Than Gaylord Qty Price
AMF618SF	6"x18"-2.5"	N/A		0.2		Call
AMF714E	7"x14"-2.5"	48		0.24	Call	Call
AMF718E	7"x18"-2.5"	24	x	0.32	Call	Call
AMF724E	7"x24"-2.5"	24		0.45	Call	Call
AMF735E	7"x35"-2.5"	24		0.67	Call	Call
AMF744E	7"x44"-2.5"	24		0.87	Call	Call
AMF818E	8"x18"-2.5"	28	x	0.43	Call	Call
AMF835E	8"x35"-2.5"	18		0.88	Call	Call
AMF844E	8"x44"-2.5"	18	x	1.14	Call	Call
AMF918E	9"x18"-2.5"	28		0.53	Call	Call
AMF942E	9"x42"-2.5"	16	X	1.38	Call	Call
AMF942WC	9"x42"-2.5"			1.38	Call	
AMF1044E	10"x40"-2.5"	12		1.78	Call	Call
AMF1054E	10"x54"-2.5"	16		2.21	Call	Call
AMF1236E2.5	12"x36"-2.5"	12		2.02	Call	Call
AMF1236E4.5	12"x36"-4.5"	12		2.02	Call	Call
AMF1242E4.5	12"x42"-4.5"	9	x	2.41	Call	Call
AMF1242WC4.5	12"x42"-4.5"			2.41	Call	
AMF1242E2.5	12"x42"-2.5"	9		2.41	Call	Call
AMF1252E2.5	12"x52"-2.5"	9		3.06	Call	Call
AMF1252E4.5	12"x52"-4.5"	9		3.06	Call	
AMF1447E	14"x47"-4.5"	8	X	3.65	Call	Call
AMF1447WC	14"x47"-4.5"			3.65	Call	
AMF1465E	14"x65"-4.5"	9 minimum		5.1	Call	
Dist Assy 13/16"	.810 OD				Call	
Dist Assy 1/2"	.845 OD				Call	
Dist Assy 1"	1.315 OD				Call	

RESILITES

R7031-10K	120V 10K ohm 1/2"	\$64.20	R7046-20K	120V 20K ohm 3/4"	\$64.20
R7031-20K	120V 20K ohm 1/2"	\$64.20	R7046-50K	120V 50K ohm 3/4"	\$64.20
R7031-50K	120V 50K ohm 1/2"	\$64.20	R7046-200K	120V 200K ohm 3/4"	\$64.20
R7031-200K	120V 200K ohm 1/2"	\$64.20	R7046-500K	120V 500K ohm 3/4"	\$64.20
R7031-500K	120V 500K ohm 1/2"	\$64.20	R7046-1MEG	120V 1MEG ohm 3/4"	\$64.20
R7031-1MEG	120V 1MEG ohm 1/2"	\$64.20	R7009	2.5" Head	\$16.47
R7046-10K	120V 10K ohm 3/4"	\$64.20	R7011	Plastic Tee 1/2" Lights	\$4.19
			R6002	Sch 80 Tee 1/2" Lights	\$23.48

--"E" Tanks are made by Enpress. Expect 15 day lead time if non-stock. Shipped from Ohio. Will stock additional tanks if requested. Rubber bumper and specially designed for DI, plastic base. 50+ other size tanks available. Colors - Natural, Blue, Almond, Gray and Black.

--"WC" Tanks are made by Wave Cyber. Rubber base and rubber bumper.

--Prices shown are for tank, base, and bumper only.

--We do offer Enpress, Structural Fibers, and Wave Cybers entire line of fiberglass tanks.

--Ask for tank assembly number that includes the tank, head, fittings, and/or distributor, specific to your needs.

AM Products & Services

www.amproduct.com

Stainless Steel Tanks



Description	Dia.	Side Shell & Head Thickness		Full Pallet Qty.	Price
		S.S.	Head		
CULLIGAN STYLE - TWO 3/4" THREADED TOP OPENING					
AMC-944	9"	14GA	12GA	25	\$239.79
AMC-944-316	9"	14GA	12GA	25	\$358.19
AMC-944-BR-316	9"	14GA	12GA	25	\$420.89
AMC-944-BR	9"	14GA	12GA	25	\$281.44
AMC-844	8"	14GA	12GA	30	\$220.15
AMC-744	6.75"	14GA	14GA	36	\$193.97
AMC-744-316	6.75"	14GA	14GA	36	Call
AMC-819(D-50)	8"	14GA	12GA	50	\$128.52
AMC-819-316	8"	14GA	12GA	50	\$186.26

CULLIGAN STYLE WITH ONLY A 2.5-8 THREADED TOP OPENING

AMD-1054	10"	14GA	12GA	20	\$354.03
AMD-1052	10"	14GA	12GA	20	\$348.67
AMD-1048	10"	14GA	12GA	20	\$310.00
AMD-1044	10"	14GA	12GA	20	\$298.69
AMD-948	9"	14GA	12GA	25	\$295.72
AMD-944	9"	14GA	12GA	25	\$277.27
AMD-848	8"	14GA	12GA	30	\$282.63
AMD-840	8"	14GA	12GA	30	\$261.21
AMD-744	6.75"	14GA	14GA	36	\$234.43
AMD-1054-316	10"	14GA	12GA	Call	Call

RAYNE STYLE TANKS - TWO 1" AND ONE 1.5" TOP OPENING

AMS-61	10"	14GA	12GA	20	\$242.76
AMS-45	8"	14GA	12GA	30	\$210.04
AMS-28	6"	14GA	14GA	36	\$181.48
AMS-61B - TOP HANDLE	10"	14GA	12GA	20	\$272.51

SPECIAL SIZE RAYNE STYLE (NO HANDLE)

AMR-1040	10"	14GA	12GA	20	\$272.51
AMR-1044	10"	14GA	12GA	20	\$282.63
AMR-1048	10"	14GA	12GA	20	\$293.93

SERVISOFT STYLE - ONE 3/4" & ONE 1.5" TOP OPENING & ONE LOWER SIDE OPENING

AM-54	10"	14GA	12GA	20	\$266.56
AM-36	8"	14GA	12GA	30	\$210.04
AM-24	6"	14GA	14GA	36	\$181.48
AM-25	8"x29"	14GA	12GA	30	\$201.63

-- All tanks from 304 Stainless Steel material unless otherwise noted-316 available upon request
(please call for pricing)

-- 304 Stainless not recommended for carbon. Use 316SS or fiberglass

-- Due to changes in our material costs, prices subject to change without notice.

-- 304 - 140 degrees F 100PSI

-- 316 - 200 degrees F 100PSI

--Custom sizes and opening available

Bypasses

Part No.	Item Description	Qty 1-19	Qty 20+
4400LF	3/4" Sweat x 3/4" Thread	\$91.11	\$88.81
4401LF	3/4" Thread x 3/4" Thread	\$91.11	\$88.81
4402LF	3/4" Sweat x 3/4" Sweat	\$91.11	\$88.81
4410LF	1" Sweat x 1" Sweat	\$91.11	\$88.81
4411LF	1" Sweat x 1" Thread	\$91.11	\$88.81
4412LF	1" Sweat x 3/4" Thread	\$91.11	\$88.81
4413LF	1" Thread x 1" Thread	\$91.11	\$88.81
4445	O-Ring	\$0.13	500+ \$0.11
4445-EPDM	O-Ring	\$0.21	
4446	Quad-Ring	\$0.19	500+ \$0.17
1078037	Service Sticker	\$0.13	
1078160	Bypass Sticker	\$0.13	
3464	Watts Culligan Style Push Rod	\$15.06	
4444	Watts Divertaflo Style Push Rod (Discontinued, use #4420)		
4420	Push Rod-Delrin 7-15/16"	\$14.00	



- Special California Customer Shipping Rates
- Multiples of 20: 1/2 Price Shipping
- 100+: FREE Shipping
- Other Configurations Available
- 20+ Orders Shipped From California
- Bypass Body - Lead Free Brass

- #3464 - 160 Degrees F

- #4420 - 250 Degrees F

- When plumbing bypass, the "IN" and "OUT" must face house plumbing.

Cart Parts

Part #	Description	Price
500001	12" Slick Wheel Used on Tank Cart*	\$62.61
500002	12" Treaded Wheel Used on Tank Cart*	\$67.95
500003	12" Inner Tube	\$8.25
500004	5/8" Bearing	\$2.48
500005	3/4" Bearing	\$2.48
500006	3/4" Roller Bearing	\$7.55
500008	Salt Plate for Tank Cart	\$50.38
510001	10" Slick Wheel Assembly for Bottled Water Cart	\$50.50
510008	10" Treaded Wheel Assembly for Bottled Water Cart	\$38.44
510008FF	10" Treaded Flat Free Wheel Assembly for Bottled Water Cart	\$44.95
510003	Stair Climber for Bottled Water Cart	\$38.06
510004	Bottom Tray for Bottled Water Cart	\$107.44
510005	Upper Trays for Bottled Water Cart	\$38.66
510006	Bottom Plate for Bottled Water Cart (H nose)	\$76.88
510007	Tray Kit (5 bottle)	\$256.88

*Specify bearing size & hub length

-- Other parts available for carts

Carrying Slings & Aprons

Part #	Description	Price
500070	Sling - Small 32"	83.83
500071	Sling - Medium 34"	83.83
500072	Sling - Large 36"	83.83
500073	Sling - X-Large 38"	83.83
500074	Sling - XX-Large 40"	83.83
	(Custom sizes available)	
500021	Reinforced Water Resistant Apron	86.25
500450	Backwash Apron	48.75

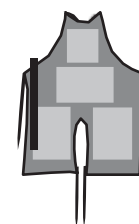
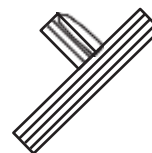

(500021)

PVC/Steel/Brass

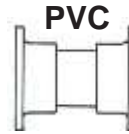

Flow Rate GPM (1)	No. of Inserts (2)	Pipe Size	Threaded N.P.T.			Plain End			Flanged			Threaded N.P.T.		
			Model No.	Price PVC	Length Inches	Model No.	Price PVC	Length Inches	Model No.	Price PVC	Length Inches	Model No.	Price Steel	Length Inches
0.25-3.5	1	1/2	TH-050-1	9.48	2	PE-050-1	9.48	5	FL-050-1	44.13	5			
0.25-10	1	3/4	TH-075-1	9.67	2	PE-075-1	9.67	5	FL-075-1	46.78	5	ST-075-1	12.40	2.5
5-10	1	1	TH-100-1	12.79	3	PE-100-1	12.79	6	FL-100-1	54.12	6	ST-100-1	15.29	3
12,15,20	1	1	TH-100-1C	13.24	3	PE-100-1C	13.24	6	FL-100-1C	54.57	6	ST-100-1C	15.74	3
10-20	2	1-1/4	TH-125-2	22.30	3	PE-125-2	22.30	6	FL-125-2	64.90	6	ST-125-2	29.11	3
20-40	4	1-1/2	TH-150-4	28.17	3	PE-150-4	28.17	6	FL-150-4	64.90	6	ST-150-4	37.24	3
35-70	7	2	TH-200-7	40.56	3	PE-200-7	40.56	6	FL-200-7	98.48	6	ST-200-7	52.04	3
45-90	9	2-1/2	TH-250-9	53.62	4	PE-250-9	53.62	6	FL-250-9	143.05	6	ST-250-9	70.63	4
70-140	14	3	TH-300-14	64.81	4	PE-300-14	64.81	6	FL-300-14	163.57	6	ST-300-14	109.87	4
125-250	25	4	TH-400-25	108.12	4	PE-400-25	108.12	6	FL-400-25	233.10	6	ST-400-25	147.47	4
270-570	54	6	TH-600-54	285.12	5	PE-600-54	285.12	8	FL-600-54	481.77	8.5	ST-600-54	347.07	5

(No 4 gpm available)

Sch. 80 Except for 6" - Sch. 40

LF Brass



Flow Rate GPM (1)	No. of Inserts (2)	Pipe Size	Threaded N.P.T.		
			Model No.	Price Brass	Length Inches
0.25-3.5	1	1/2	BR1-050-1	12.94	2
5-10	1	1/2	BR2-050-1	13.97	2

PVC



Flow Rate GPM (1)	No. of Inserts (2)	Pipe Size	DISC (3)		
			Model No.	Price Brass	Length Inches
35-70	7	2	D1-200-7	80.36	15/16
45-90	9	2.5	D1-250-9	100.79	15/16
70-140	14	3	D1-300-14	114.73	15/16
125-250	25	4	D1-400-25	164.93	15/16
270-540	54	6	D1-600-54	339.23	15/16

- (1) Flow rates for 3/4" through 6" flow controllers with flow rates from 5-540 GPM are in increments of 1 GPM See Table B
Flow rates for 1/2" and 3/4" flow controllers for flow rates from 0.25 to 3.5 GPM See Table A
Only flow rates 12, 15 and 20 GPM are available in Model No. 100-1C. See Table C. Flow rates for 1/2" Brass 0.25 to 10 GPM See Table A & B
- (2) Maximum number of flow inserts in a given nipple size. Flow Controls can be made with fewer flow inserts, for less flow than minimum listed. Indicated prices will apply.
- (3) Installs between two standard flanges, bolts must be a minimum of 1" longer than normally required. Gasket required on both sides.

When ordering specify Model No. and flow rate.

The Buna flow control inserts are not recommended for DI regenerant chemicals. Call for pricing on special DI flow controls.

TABLE A

Inserts 0.25 to 3.5 GPM Buna
Not color coded (Black) \$2.65

0.25 GPM	1.40 GPM
0.40 GPM	1.60 GPM
0.50 GPM	1.80 GPM
0.60 GPM	2.00 GPM
0.70 GPM	2.20 GPM
0.90 GPM	2.50 GPM
1.00 GPM	3.00 GPM
1.20 GPM	3.50 GPM

TABLE B

Color Identification of
BUNA Inserts \$2.65

- 5 GPM -- Blue
- 6 GPM -- Red
- 7 GPM -- Brown
- 8 GPM -- Green
- 9 GPM -- White
- 10 GPM -- Rust

TABLE C

Inserts 12-20 GPM Buna
Not color coded (Black) \$2.65

- 12 GPM
- 15 GPM
- 20 GPM

Standard, Side Loader & Salt Carts

- 1" x 14 gauge (.083) cold rolled steel tubing
- Mig Welded
- Black texture - powder coated
- 3/4" solid steel axle
- 12" pneumatic slick wheels with 3 piece hubs and roller bearings
- Capacity 800#
- UPS shippable (45x20x17)
- Tank cart heights measured in laid back position. This must be taken into account when comparing height to other carts
- Specially designed to cradle mineral & resin tanks
- **#500008 Optional salt plate for standard style carts \$50.38**
Attaches & detaches in seconds
12" x 20"



Tank Carts

Standard Tank Cart

#500000 - \$374.20
21"W x 45"H; 35 lbs
Tanks up to 12" diameter

Standard Tank Cart without bottom loops

#500010 - \$374.20
21"W x 45" H; 34 lbs Tanks
up to 10" diameter

Large Tank Cart

#550000 - \$379.27
24"W x 45"H; 36 lbs
Tanks up to 18" Diameter

Double Tank Cart

#560000 - \$402.15
26"W x 46"H; 51 lbs
Two Tanks up to 12"
Diameter One Tank up to 30"
Diameter

Salt Cart

#570000 - \$374.88

- 21.5"W x 49"H
- 32 lbs
- 10" Pneumatic treaded tires
- 500# capacity, aluminum construction, stair climbers, wheel guards, curved back. Bottom plate 12" x 14"



Side Loader Carts

9" Sideloader

#500020 - \$374.20
20"W x 44"H; 29 lbs
Tanks up to 9"
diameter

14" Sideloader

#500030 - \$391.95
23.5"W x 44"H; 34 lbs
Tanks up to 14"
diameter

Bottle Water Cart - 3 Position



#520000 - \$763.31

- Easily converts from standard 2-wheel to 4-wheel inclined to 4-wheel platform truck. Carries up to 12 bottles.
- Option - Slick Tires \$101.00
- Flat Free Tires - \$35.75
- Other wheels and handle styles available

2 Wheel Dimensions: 51" H x 21" W

- Capacity: 500# Weight: 43#
- Bottom Plate: 18"W x 7.5" D
- Recessed nose: 9"W x 27" D (300# Capacity)

4 Wheel Dimensions: 40"H x 21"W x 54"L

Capacity: 750# Weight: 43#



5-Bottle Hand Truck

#510000 - \$523.13

Non-slip trays easily fold to convert this cart to a standard hand truck.

- Dimensions: 21.5"W x 49" H
- Capacity: 500#
- Frame Material: Aluminum
- Weight: 28#
- Bottom Plates: 14"W x 12"D
- Tires: 10" Treaded Pneumatic

Options

- 8" Hard tires deduct \$20.00
- Slick tires - Used where tracking dirt is a concern - \$101.00
- Flat Free Tires - \$35.75
- Stair climbers - Greatly improves deliveries where there is a need to navigate stairways - \$38.00
- Additional handle and tires styles available - Call for pricing

Fully Automatic Water Jet Eductor

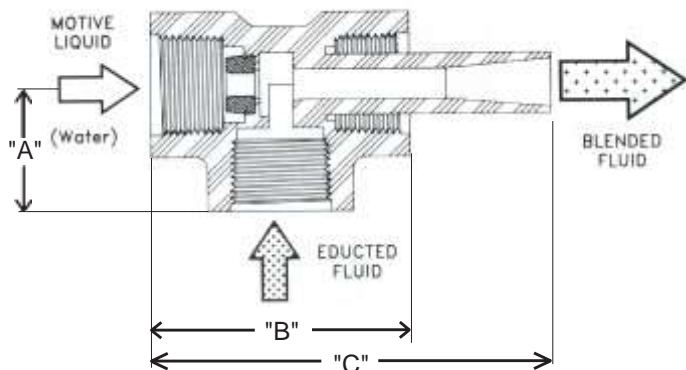

- Flexible flow control orifice automatically maintains a constant liquid flow regardless of variations in inlet water pressure
- Corrosion resistant materials of construction: eductor body: schedule 80 polyvinylchloride; PVC Type 1, Grade 1; Flow control insert: precision molded buna (N)
- Wide operating pressure range: 30-120 PSIG; Maximum operating temperature: 100 degrees Fahrenheit
- Standard models available from stock; custom configurations available on request
- Other materials of construction available.

IMPORTANT APPLICATION NOTES: These eductors are designed for operation with water as the operating medium. All applications should be carefully tested for flow characteristics and compatibility of the motive liquid and educted chemicals to insure desired results. Swelling of the flow control insert in certain liquids will result in loss of flow rate accuracy.

Model Number	Motive Water Flow Rate	Pipe Size (NPT)	Dimensions (Inches)		
			"A"	"B"	"C"
0.9 - 050 1.2 - 050 1.4 - 050 2.0 - 050	0.9 GPM 1.2 GPM 1.4 GPM 2.0 GPM	1/2"	1.35	2.74	--
2.5 - 075 3.5 - 075 5.0 - 075	2.5 GPM 3.5 GPM 5.0 GPM	3/4"	1.62	3.22	4.40
7 - 100 10 - 100	7 GPM 10 GPM	1"	1.85	3.64	5.45
12 - 150 15 - 150 20 - 150	12 GPM 15 GPM 20 GPM	1-1/2"	2.09	4.16	6.05

NOTES: Data based on: 1) Motive water flow rate +/- 10 percent @ 30-120 PSIG and 60 degrees F. 2) Motive liquid: Educted liquid = 1:1 with educted fluids similar to water (e.g. Sp.Gr = 1.0 and viscosity = 1.0 Centipoise @ 60 degrees F.) 3) Suction lift = 4.0 Ft and discharge head = 0 Ft.

Typical Water Softener Applications

Tank Dia.	Area Sq. Ft.	Resin Volume, Cu. Ft.		Eductor Model No:	Rinse GPM
		Min. ¹⁾	Max. ²⁾		
12	0.8	1.6	3.1	0.9-050	0.9
14	1.1	2.1	4.3	1.2-050	1.2
16	1.4	2.8	5.6	1.4-050	1.4
18	1.8	3.5	7.1	2.0-050	2.0
20	2.2	4.4	8.7	2.5-075	2.5
24	3.1	6.3	12.6	3.5-075	3.5
30	4.9	9.8	19.6	5.0-075	5.0
36	7.1	14.1	28.3	7-100	7
42	9.6	19.2	38.5	10-100	10
48	12.6	25.1	50.3	12-150	12
54	15.9	31.8	63.6	15-150	15
60	19.6	39.3	78.5	20-150	20

Model No.	Pipe Size (NPT)	Price
0.9-050	1/2	43.46
1.2-050	1/2	43.46
1.4-050	1/2	43.46
2.0-050	1/2	43.46
2.5-075	3/4	51.70
3.5-075	3/4	51.70
5.0-075	3/4	51.70
7.0-100	1	51.70
10-100	1	63.96
12-150	1-1/2	63.96
15-150	1-1/2	63.96
20-150	1-1/2	63.96

(1) Based on 24" minimum bed depth.

(2) At minimum 0.25 GMP/Cu. Ft. rinse rate.









(3) Regeneration with saturated salt (NaCl) brine as the educted liquid will yield brine flow < rinse flow. The ratio is dependent on many factors including discharge head (pipe design, bed depth, installation, etc.) and suction lift (brine valve design and size, installation, etc.)

Note: Above eductors not recommended for use with DI regen chemicals. Call for special DI eductor pricing.

No Adjustable Throat or Nozzle.

00-200	2"	122.09
00-250	2.5"	203.10

Cam Couplings

<p>Part A</p>  <p>Adapter X Female NPT</p> <table border="1"> <thead> <tr> <th>Size</th> <th>NY-Glass</th> <th>Polyglass</th> </tr> </thead> <tbody> <tr><td>1/4"</td><td>\$4.09</td><td>3.49</td></tr> <tr><td>3/8"</td><td>4.09</td><td>3.49</td></tr> <tr><td>1/2"</td><td>3.63</td><td>3.49</td></tr> <tr><td>3/4"</td><td>3.82</td><td>3.49</td></tr> <tr><td>1"</td><td>4.31</td><td>3.63</td></tr> <tr><td>*1-1/4"</td><td>6.81</td><td>4.45</td></tr> <tr><td>1-1/2"</td><td>6.36</td><td>4.45</td></tr> <tr><td>2"</td><td>6.97</td><td>5.23</td></tr> <tr><td>3"</td><td>15.02</td><td>12.49</td></tr> <tr><td>4"</td><td>27.90</td><td>23.14</td></tr> </tbody> </table> <p>*Coupler Side 1-1/2"</p>	Size	NY-Glass	Polyglass	1/4"	\$4.09	3.49	3/8"	4.09	3.49	1/2"	3.63	3.49	3/4"	3.82	3.49	1"	4.31	3.63	*1-1/4"	6.81	4.45	1-1/2"	6.36	4.45	2"	6.97	5.23	3"	15.02	12.49	4"	27.90	23.14	<p>Part B</p>  <p>Coupler X Male NPT With Stainless Steel Handles</p> <table border="1"> <thead> <tr> <th>Size</th> <th>NY-Glass</th> <th>Polyglass</th> </tr> </thead> <tbody> <tr><td>1/2"</td><td>\$9.38</td><td>8.42</td></tr> <tr><td>3/4"</td><td>10.47</td><td>8.85</td></tr> <tr><td>1"</td><td>11.40</td><td>10.94</td></tr> <tr><td>*1-1/4"</td><td>14.41</td><td>12.31</td></tr> <tr><td>1-1/2"</td><td>14.46</td><td>12.31</td></tr> <tr><td>2"</td><td>16.27</td><td>13.59</td></tr> <tr><td>3"</td><td>27.20</td><td>23.14</td></tr> <tr><td>4"</td><td>38.54</td><td>58.63</td></tr> </tbody> </table> <p>*Coupler Side 1-1/2"</p>	Size	NY-Glass	Polyglass	1/2"	\$9.38	8.42	3/4"	10.47	8.85	1"	11.40	10.94	*1-1/4"	14.41	12.31	1-1/2"	14.46	12.31	2"	16.27	13.59	3"	27.20	23.14	4"	38.54	58.63	<p>Part C</p>  <p>Coupler X Hose Shank With Stainless Steel Handles</p> <table border="1"> <thead> <tr> <th>Size</th> <th>NY-Glass</th> <th>Polyglass</th> </tr> </thead> <tbody> <tr><td>1/2"</td><td>\$9.06</td><td>8.42</td></tr> <tr><td>3/4"</td><td>11.20</td><td>8.42</td></tr> <tr><td>1"</td><td>10.36</td><td>10.06</td></tr> <tr><td>*1-1/4"</td><td>14.96</td><td>12.31</td></tr> <tr><td>1-1/2"</td><td>14.41</td><td>12.56</td></tr> <tr><td>2"</td><td>18.92</td><td>14.47</td></tr> <tr><td>3"</td><td>26.41</td><td>23.11</td></tr> <tr><td>4"</td><td>38.46</td><td>48.86</td></tr> </tbody> </table> <p>*Coupler Side 1-1/2"</p>	Size	NY-Glass	Polyglass	1/2"	\$9.06	8.42	3/4"	11.20	8.42	1"	10.36	10.06	*1-1/4"	14.96	12.31	1-1/2"	14.41	12.56	2"	18.92	14.47	3"	26.41	23.11	4"	38.46	48.86			
Size	NY-Glass	Polyglass																																																																																										
1/4"	\$4.09	3.49																																																																																										
3/8"	4.09	3.49																																																																																										
1/2"	3.63	3.49																																																																																										
3/4"	3.82	3.49																																																																																										
1"	4.31	3.63																																																																																										
*1-1/4"	6.81	4.45																																																																																										
1-1/2"	6.36	4.45																																																																																										
2"	6.97	5.23																																																																																										
3"	15.02	12.49																																																																																										
4"	27.90	23.14																																																																																										
Size	NY-Glass	Polyglass																																																																																										
1/2"	\$9.38	8.42																																																																																										
3/4"	10.47	8.85																																																																																										
1"	11.40	10.94																																																																																										
*1-1/4"	14.41	12.31																																																																																										
1-1/2"	14.46	12.31																																																																																										
2"	16.27	13.59																																																																																										
3"	27.20	23.14																																																																																										
4"	38.54	58.63																																																																																										
Size	NY-Glass	Polyglass																																																																																										
1/2"	\$9.06	8.42																																																																																										
3/4"	11.20	8.42																																																																																										
1"	10.36	10.06																																																																																										
*1-1/4"	14.96	12.31																																																																																										
1-1/2"	14.41	12.56																																																																																										
2"	18.92	14.47																																																																																										
3"	26.41	23.11																																																																																										
4"	38.46	48.86																																																																																										
<p>Part D</p>  <p>Coupler X Female NPT With Stainless Steel Handles</p> <table border="1"> <thead> <tr> <th>Size</th> <th>NY-Glass</th> <th>Polyglass</th> </tr> </thead> <tbody> <tr><td>1/4"</td><td>\$9.62</td><td>-</td></tr> <tr><td>3/8"</td><td>9.62</td><td>8.42</td></tr> <tr><td>1/2"</td><td>9.06</td><td>8.42</td></tr> <tr><td>3/4"</td><td>9.06</td><td>8.42</td></tr> <tr><td>1"</td><td>10.21</td><td>9.47</td></tr> <tr><td>*1-1/4"</td><td>15.08</td><td>9.94</td></tr> <tr><td>1-1/2"</td><td>14.68</td><td>10.85</td></tr> <tr><td>2"</td><td>16.37</td><td>13.64</td></tr> <tr><td>3"</td><td>28.20</td><td>23.11</td></tr> <tr><td>4"</td><td>40.90</td><td>48.86</td></tr> </tbody> </table> <p>*coupler side 1-1/2"</p>	Size	NY-Glass	Polyglass	1/4"	\$9.62	-	3/8"	9.62	8.42	1/2"	9.06	8.42	3/4"	9.06	8.42	1"	10.21	9.47	*1-1/4"	15.08	9.94	1-1/2"	14.68	10.85	2"	16.37	13.64	3"	28.20	23.11	4"	40.90	48.86	<p>Part E</p>  <p>Adapter X Hose Shank</p> <table border="1"> <thead> <tr> <th>Size</th> <th>NY-Glass</th> <th>Polyglass</th> </tr> </thead> <tbody> <tr><td>1/2"</td><td>\$4.83</td><td>3.84</td></tr> <tr><td>5/8"</td><td>5.06</td><td>-</td></tr> <tr><td>3/4"</td><td>4.83</td><td>3.84</td></tr> <tr><td>1"</td><td>5.54</td><td>4.47</td></tr> <tr><td>*1-1/4"</td><td>6.77</td><td>4.67</td></tr> <tr><td>1-1/2"</td><td>6.48</td><td>4.67</td></tr> <tr><td>2"</td><td>7.48</td><td>5.79</td></tr> <tr><td>3"</td><td>14.32</td><td>15.64</td></tr> <tr><td>4"</td><td>26.47</td><td>23.16</td></tr> </tbody> </table> <p>*Coupler Side 1-1/2"</p>	Size	NY-Glass	Polyglass	1/2"	\$4.83	3.84	5/8"	5.06	-	3/4"	4.83	3.84	1"	5.54	4.47	*1-1/4"	6.77	4.67	1-1/2"	6.48	4.67	2"	7.48	5.79	3"	14.32	15.64	4"	26.47	23.16	<p>Part F</p>  <p>Adapter X Male NPT</p> <table border="1"> <thead> <tr> <th>Size</th> <th>NY-Glass</th> <th>Polyglass</th> </tr> </thead> <tbody> <tr><td>1/2"</td><td>\$4.82</td><td>3.84</td></tr> <tr><td>3/4"</td><td>5.56</td><td>4.42</td></tr> <tr><td>1"</td><td>5.45</td><td>5.16</td></tr> <tr><td>*1-1/4"</td><td>7.09</td><td>4.67</td></tr> <tr><td>1-1/2"</td><td>6.75</td><td>4.67</td></tr> <tr><td>2"</td><td>7.22</td><td>6.22</td></tr> <tr><td>3"</td><td>18.06</td><td>15.65</td></tr> <tr><td>4"</td><td>28.89</td><td>23.16</td></tr> </tbody> </table> <p>*Coupler Side 1-1/2"</p>	Size	NY-Glass	Polyglass	1/2"	\$4.82	3.84	3/4"	5.56	4.42	1"	5.45	5.16	*1-1/4"	7.09	4.67	1-1/2"	6.75	4.67	2"	7.22	6.22	3"	18.06	15.65	4"	28.89	23.16
Size	NY-Glass	Polyglass																																																																																										
1/4"	\$9.62	-																																																																																										
3/8"	9.62	8.42																																																																																										
1/2"	9.06	8.42																																																																																										
3/4"	9.06	8.42																																																																																										
1"	10.21	9.47																																																																																										
*1-1/4"	15.08	9.94																																																																																										
1-1/2"	14.68	10.85																																																																																										
2"	16.37	13.64																																																																																										
3"	28.20	23.11																																																																																										
4"	40.90	48.86																																																																																										
Size	NY-Glass	Polyglass																																																																																										
1/2"	\$4.83	3.84																																																																																										
5/8"	5.06	-																																																																																										
3/4"	4.83	3.84																																																																																										
1"	5.54	4.47																																																																																										
*1-1/4"	6.77	4.67																																																																																										
1-1/2"	6.48	4.67																																																																																										
2"	7.48	5.79																																																																																										
3"	14.32	15.64																																																																																										
4"	26.47	23.16																																																																																										
Size	NY-Glass	Polyglass																																																																																										
1/2"	\$4.82	3.84																																																																																										
3/4"	5.56	4.42																																																																																										
1"	5.45	5.16																																																																																										
*1-1/4"	7.09	4.67																																																																																										
1-1/2"	6.75	4.67																																																																																										
2"	7.22	6.22																																																																																										
3"	18.06	15.65																																																																																										
4"	28.89	23.16																																																																																										
<p>Part DP</p>  <p>Adapter Dust Plug</p> <table border="1"> <thead> <tr> <th>Size</th> <th>NY-Glass</th> <th>Polyglass</th> </tr> </thead> <tbody> <tr><td>3/4"</td><td>\$3.84</td><td>3.78</td></tr> <tr><td>1"</td><td>4.31</td><td>3.68</td></tr> <tr><td>1 1/2"</td><td>5.18</td><td>4.25</td></tr> <tr><td>2"</td><td>6.27</td><td>5.76</td></tr> <tr><td>3"</td><td>15.64</td><td>12.48</td></tr> <tr><td>4"</td><td>19.85</td><td>18.20</td></tr> </tbody> </table>	Size	NY-Glass	Polyglass	3/4"	\$3.84	3.78	1"	4.31	3.68	1 1/2"	5.18	4.25	2"	6.27	5.76	3"	15.64	12.48	4"	19.85	18.20	<p>Part DC</p>  <p>Coupler Dust Cap With Stainless Steel Handles</p> <table border="1"> <thead> <tr> <th>Size</th> <th>NY-Glass</th> <th>Polyglass</th> </tr> </thead> <tbody> <tr><td>3/4"</td><td>\$9.74</td><td>9.67</td></tr> <tr><td>1"</td><td>9.62</td><td>9.47</td></tr> <tr><td>1 1/2"</td><td>14.22</td><td>12.00</td></tr> <tr><td>2"</td><td>16.00</td><td>13.95</td></tr> <tr><td>3"</td><td>24.68</td><td>23.11</td></tr> <tr><td>4"</td><td>33.11</td><td>35.63</td></tr> </tbody> </table>	Size	NY-Glass	Polyglass	3/4"	\$9.74	9.67	1"	9.62	9.47	1 1/2"	14.22	12.00	2"	16.00	13.95	3"	24.68	23.11	4"	33.11	35.63	<p>Notes: --Coupler & Adapter side on 1/2" side is 3/4" --Parts also available in PVDF, PVC, Food-Flo, Stainless Steel, Brass & Aluminum 220316 - 7" inlet screen 3/4 Fitting \$3.50</p>																																																
Size	NY-Glass	Polyglass																																																																																										
3/4"	\$3.84	3.78																																																																																										
1"	4.31	3.68																																																																																										
1 1/2"	5.18	4.25																																																																																										
2"	6.27	5.76																																																																																										
3"	15.64	12.48																																																																																										
4"	19.85	18.20																																																																																										
Size	NY-Glass	Polyglass																																																																																										
3/4"	\$9.74	9.67																																																																																										
1"	9.62	9.47																																																																																										
1 1/2"	14.22	12.00																																																																																										
2"	16.00	13.95																																																																																										
3"	24.68	23.11																																																																																										
4"	33.11	35.63																																																																																										

Cam Coupling Accessories Handle Assembly Parts









Size	Standard Package	Stainless Steel Handles	Groove Pins	Safety Locks	Handle Rings
Small	150	\$2.14	\$0.74	\$0.33 1/2"to1"	
Medium	100'	\$2.79	\$0.86		\$0.33
Large	50	\$4.75	\$1.28	\$0.45 1-1/4"+ 2"	

220316 Inlet Distributor for 3/4" cam coupling .6 x 7" x .84 Flare \$2.47
 Pure Water Tank Adapters
 2 1/2 Tank Thread 3/4" Openings Nyglass - \$13.73 Polyglass - \$12.97

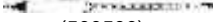
Gaskets

Size	Buna-N	EPDM	Viton	White FDA	Shims
3/4"	\$0.92	\$0.65	\$2.50	\$4.34	\$0.20
1"	0.99	0.66	11.79	4.34	0.28
1 1/2"	1.24	0.93	11.86	6.97	0.44
2"	1.27	1.04	17.44	6.92	0.54
3"	1.69	1.26	24.73	10.77	1.08
4"	2.58	2.06	38.87	12.04	1.51

Miscellaneous

	Part #	Description	Ind. Price	Price Break
	(230540)			
	230540	Rubber Boot/Funnel Connector	\$14.67	
	(230560)			
	230560	Funnel Cut-off valve 1-1/4"	66.31	
	500540	Funnel Tubing 1.5" ID Clear, Flexible PVC	7.71/ft	
	230100	Down Spout Hose Flat Dimension 8" x 94" (Custom sizes available)	76.50	
	(230100) (330571)			
	330571	Resin Overflow Bag 10 x 60 (Custom sizes available)	87.98	
	500500	0-100 Salometer	29.30	
	500501	DI Dual Read Hydrometer	35.42	
	(500500) (500501)			
	500531	Reinforced DI & Softener Hose (Gray Cover) 3/4 ID x 1.03 OD 150 PSI 150 F	2.14/ft	
	(500530)			
	500531-100	100 ft Roll		1.48/ft
	500531-300	300 ft Roll		1.38/ft
	500532	Reinforced DI & Softener Hose (Blue Cover) 3/4 ID x 1.125 OD 250 PSI 150 F	2.98/ft	
	500532-100	100 ft Roll		2.00/ft
	500532-500	500 ft. Roll		1.90/ft
	(500553)			
	500530	Reinforced Black Hose Not rated for potable water 3/4 ID x 1.12 OD 200 PSI 190 F	2.98/ft	
	500530-100	100 ft Roll		2.00/ft
	500530-500	500 ft Roll		1.90/ft
	(500040)			
	(500041)			
	500533	Reinforced DI & Softener Hose (Gray Cover) 1" ID x 1.29 OD 125 PSI 150 F	3.28/ft	
	500533-100	100 ft Roll		2.11/ft
	500533-200	200 ft Roll		1.98/ft
	(500480)			
	500553	Soft Water Test Kit	3.11	54-89 2.90 90+ 2.80
	500040	Single Tank Holder-Clamp Style	114.46	
	500041	Double Tank Holder-Clamp Style	150.62	
	500044	Springs	1.73	
	500045	Adjusters	5.77	
	(501604)			
	500480	Aluminum Scoop 45 oz.	25.55	
	501566	Heavy Plastic Drip Pan 4" x 8.75" Bottom Inside Dia. X 11.5" Outside Top Dia. x 1/8" Pkg. of 12	4.06 each	
	501604	Heavy Plastic Drip Pan 4" X 13.5" Bottom Inside Dia. X 17.5" Outside Top Dia. x 1/8" Pkg. of 12	6.27 each	
		NEW Style Drip Pan Coming - Call for details!		
	500600	Dow #7 - 5.3 oz Lubricant	18.72	
	500601	Dow #11 - 5.3 oz Lubricant	23.74	
	5111A	Hose Crimper Die Sets	Call	
	860	Hose Crimper Die Sets	Call	



4242 1st Ave Ste A
Lyons, IL 60534
Phone: 920-686-0000
Email: mail@amproduct.com

www.amproduct.com

Catalog available online